

# 外視 / External view

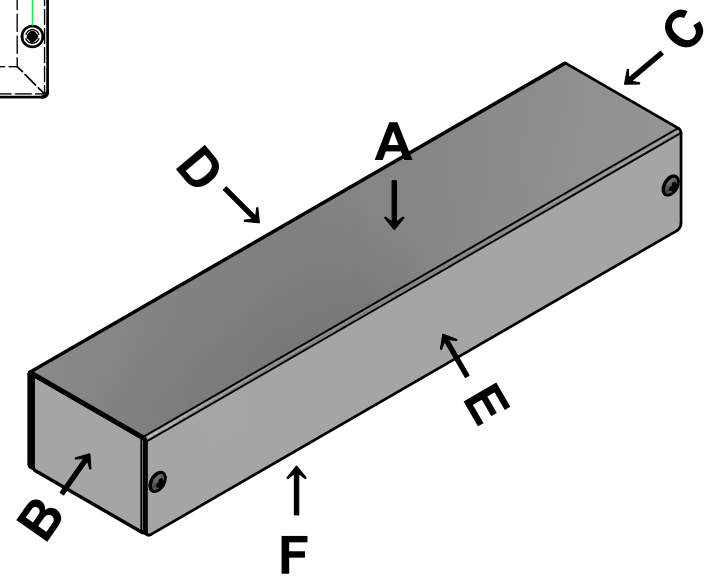
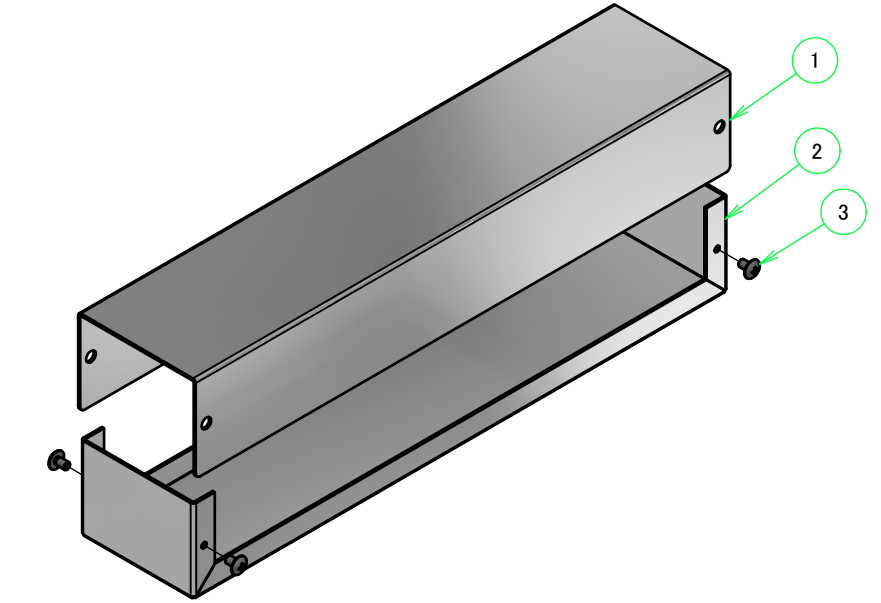
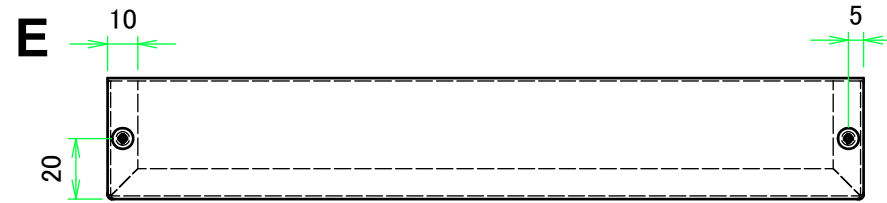
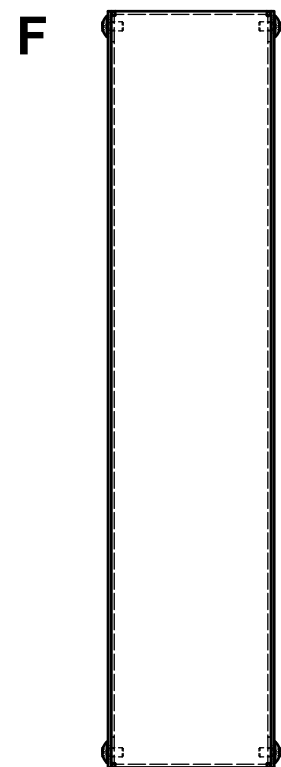
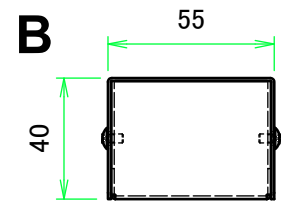
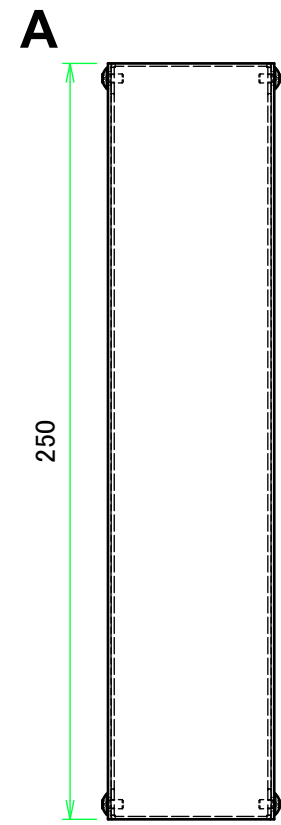
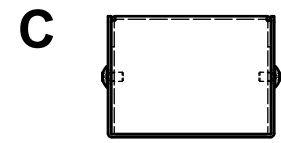

| 構成内容 |   |    |   |   |
|------|---|----|---|---|
| No.  | 名称  | 数量 | 材質  | 色・表面処理  |
| 1    | カバー<br>Cover                                | 1  | アルミ板 A1100P t1.0<br>Aluminium A1100P t1.0 | 表面 メタリックシルバー塗装, 裏面 導通処理<br>Metallic silver painted, Inside Conductivefinished |
| 2    | シャーシ<br>Base                                | 1  | アルミ板 A1100P t1.0<br>Aluminium A1100P t1.0 | 表面 メタリックシルバー塗装, 裏面 導通処理<br>Metallic silver painted, Inside Conductivefinished |
| 3    | 取付ビス(トラスM3 x 5)<br>Screw(Truss head M3 - 5) | 4  | 鉄<br>Steel                                | ニッケルメッキ<br>Nickel Plated  |

|   |            |            |                                      |                   |
|---|------------|------------|--------------------------------------|-------------------|
| <b>株式会社タカチ電機工業</b><br>TAKACHI ELECTRONICS ENCLOSURE CO., LTD. |            |            | 品名/Title<br>アルミケース<br>ALUMINIUM CASE |                   |
| 承認/Approved   | 検図/Checked | 製図/Created | 型番/Product number<br><b>MB6-4-25</b> | 尺度/Scale<br>1:2.5 |
| 中根  | 王          | 横田         | 作成日/Date<br>2022/05/20               | 1 / 3             |

カバー / Cover

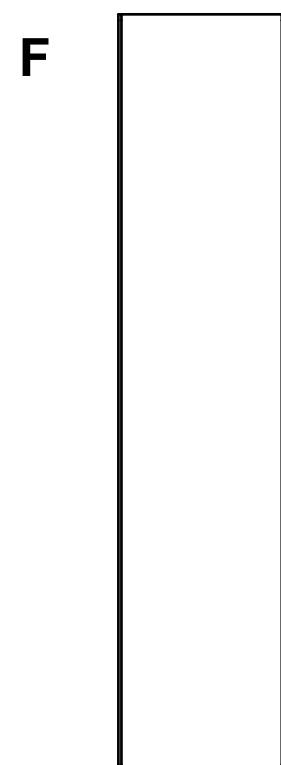
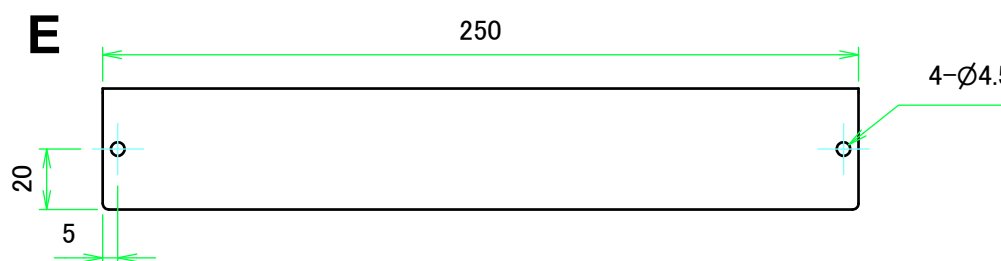
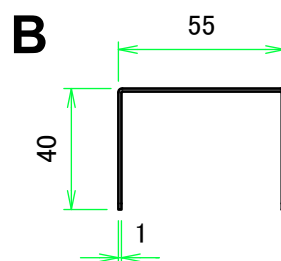
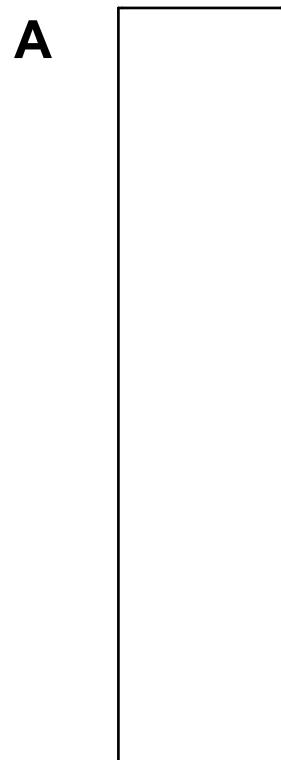

|  |                 |                                      |                   |
|--|-----------------|--------------------------------------|-------------------|
| 株式会社タカチ電機工業<br>TAKACHI ELECTRONICS ENCLOSURE CO., LTD. |                 | 品名/Title<br>アルミケース<br>ALUMINIUM CASE | 尺度/Scale<br>1:2.5 |
| 承認/Approved<br>中根                                      | 検図/Checked<br>王 | 製図/Created<br>横田                     |                   |
| 作成日/Date 2022/05/20                                    |                 |                                      | 2 / 3             |

シャーシ / Base

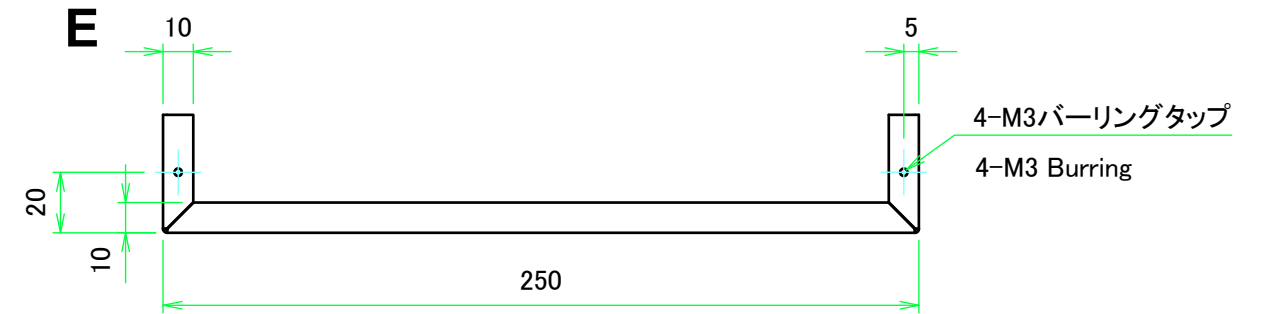
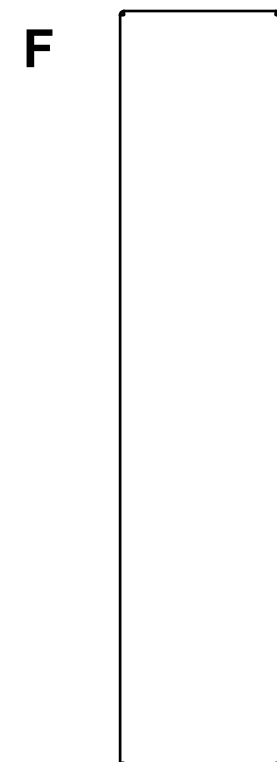
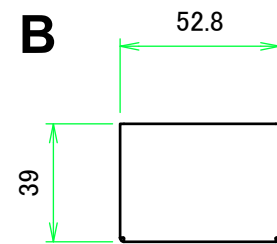
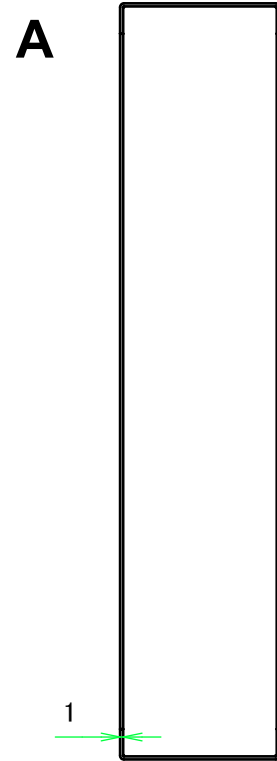
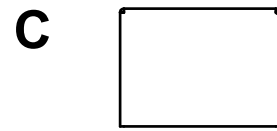

|  |            |            |                                      |                   |
|--|------------|------------|--------------------------------------|-------------------|
| 株式会社タカチ電機工業<br>TAKACHI ELECTRONICS ENCLOSURE CO., LTD. |            |            | 品名/Title<br>アルミケース<br>ALUMINIUM CASE |                   |
| 承認/Approved  | 検図/Checked | 製図/Created | 型番/Product number<br>MB6-4-25        | 尺度/Scale<br>1:2.5 |
| 中根   | 王          | 横田         | 作成日/Date<br>2022/05/20               | 3 / 3             |