

THB406 series

IP68 PANEL-MOUNT PLUG-TYPE RELAY CONNECTOR



- IP68 panel-mount plug-type connector for installation on panels or boxes.
- Set consisting of a plug (male) and socket (female).
- Plug-socket panel-mount type consisting of the plug side (male) and socket side (female).
- 3P, 6P and 8P pole models are available.
- THB406-3P is UL2238 / C22.2 No. 182.3 compliant product.
- For safety reasons, please arrange the connector such that the primary side is female (socket side) and the secondary side is male (plug side).

Technical Data
Protection class : IP68 1bar/1h (1 hour / 10m depth) Operating temperature : -40°C ~ +125°C EN61984 compliant.



THB406-3P	
Rated voltage	Max AC400V
Rated current	Max 25A (EN61984) Max 20A (UL2238/C22.2No. 182.3)
Applicable wire	Stranded wire 0.5mm ² ~ 4.0mm ²
Impulse withstand voltage	4kV
Number of insertion/extraction	1,000 times

THB406-6P	
Rated voltage	Max AC400V
Rated current	Max 17.5A
Applicable wire	Stranded wire 0.5mm ² ~ 4.0mm ²
Impulse withstand voltage	6kV
Number of insertion/extraction	1,000 times

THB406-8P	
Rated voltage	Max AC400V (DC60V)
Rated current	Max 10A AC/DC
Applicable wire	Stranded wire 0.25mm ² ~ 1.0mm ²
Impulse withstand voltage	2.5kV
Number of insertion/extraction	1,000 times

Components

No.	Part name	Pcs	Material	Color / Finish
1	Plug	1	PA66GF (UL94V-0) • PA66 (UL94V-2) • TPE	Black • Green
2	Socket	1	PA66GF (UL94V-0) • PA66 (UL94V-2) • TPE	Black • Green
3	Cap	1	PA66 (UL94V-2)	Black
4	Sealing insert	1	TPE	Green
5	Lock nut	1	PA66 (UL94V-2)	Black

■ PA66 = Polyamide 66

■ PA66GF = Glass fiber filled polyamide 66

Accessories (Optional parts)

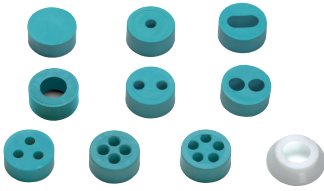

Sealing insert
See page Tool-5



Exclusive tightening tool
See page Tool-5



Sealing plug • socket cap
See page Cap-4



Exclusive terminal installation tool
See page Tool-4

How to connect

1. Connect the wires to the terminal block using a flathead (minus) screwdriver.
2. Align the terminal block with the groove and insert it into the plug / socket. Turn / twist to lock.
3. Insert the plug into the mounting hole and secure with the nut. Insert the socket into the plug and turn the retaining ring to secure.

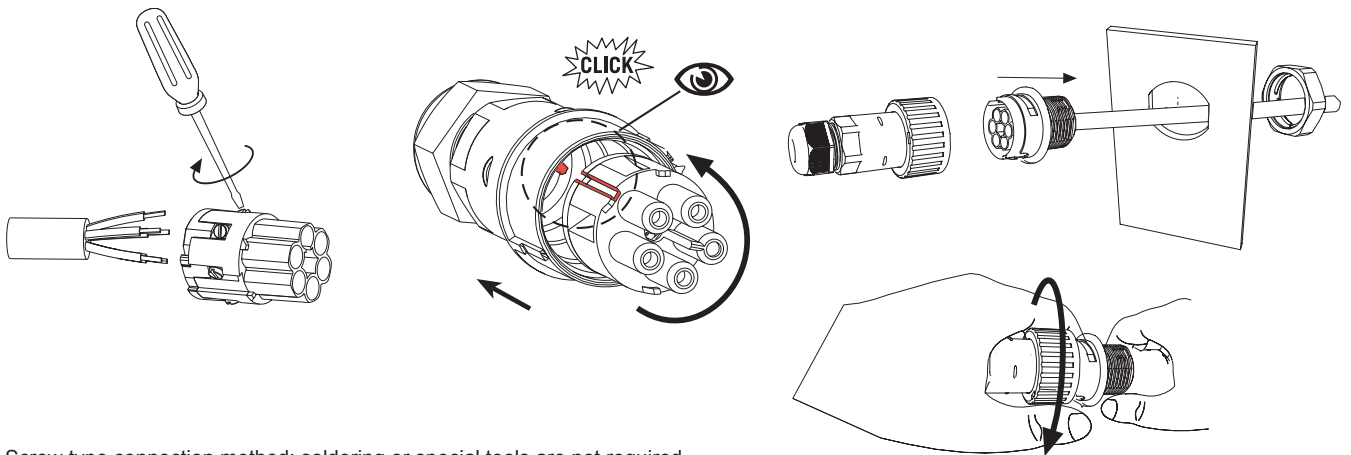

- Screw type connection method; soldering or special tools are not required.
- A flathead (minus) screwdriver of tip width 3mm is recommended.
- Screws may be screwed in firmly. Use a screwdriver with proper grip handles to loosen it.

THB406 dimensions

■ DXF/DWG/PDF drawings available on our website.

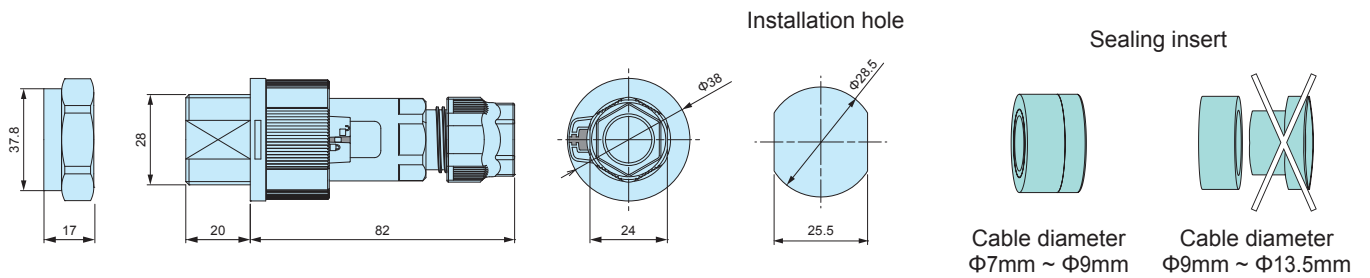

- Applicable cable size range can be expanded by removing the inner sealing insert.

Product no. / Details

Product no.	Cable range	Maximum mounting thickness (mm)	Number of poles
THB406-3P	Φ7.0 ~ Φ13.5	10	3P
THB406-6P	Φ7.0 ~ Φ13.5	10	6P
THB406-8P	Φ7.0 ~ Φ13.5	10	8P



- Plug-socket connector type consisting of the plug side (male) and socket side (female).
- A screw type wiring connection is adopted, allowing for easy installation and removal.
- 6P and 8P pole models are available.
- For safety reasons, please arrange the connector such that the primary side is female (socket side) and the secondary side is male (plug side).

Technical Data
Protection class : IP68 1bar/1h (1 hour / 10m depth) Operating temperature : -40°C ~ +125°C EN61984 compliant.



THB405-6P	
Rated voltage	Max AC400V
Rated current	Max 17.5A
Applicable wire	Stranded wire 0.5mm ² ~ 4.0mm ²
Impulse withstand voltage	6kV
Number of insertion/extraction	1,000 times

THB405-8P	
Rated voltage	Max AC400V (DC60V)
Rated current	Max 10A AC/DC
Applicable wire	Stranded wire 0.25mm ² ~ 1.0mm ²
Impulse withstand voltage	2.5kV
Number of insertion/extraction	1,000 times

Components

- PA66 = Polyamide 66
- PA66GF = Glass fiber filled polyamide 66

No.	Part name	Pcs	Material	Color / Finish
1	Plug	1	PA66GF (UL94V-0) • PA66 (UL94V-2) • TPE	Black • Green
2	Socket	1	PA66GF (UL94V-0) • PA66 (UL94V-2) • TPE	Black • Green
3	Cap	2	PA66 (UL94V-2)	Black
4	Sealing insert	2	TPE	Green

Accessories (Optional parts)

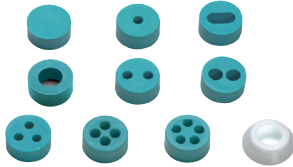

Sealing insert
See page Tool-5



Exclusive bracket
See page Tool-6



Sealing plug • socket cap
See page Cap-4



Exclusive tightening tool
See page Tool-4



Exclusive terminal installation tool
See page Tool-4

How to connect

1. Connect the wires to the terminal block using a flathead (minus) screwdriver.

2. Align the terminal block with the groove and insert it into the plug / socket. Turn / twist to lock.

3. Ensure that the plug and socket are firmly attached before turning the retaining ring to secure.

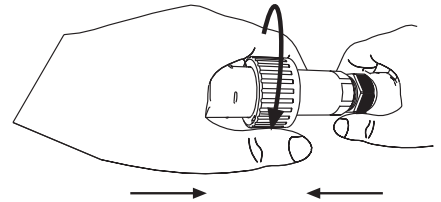
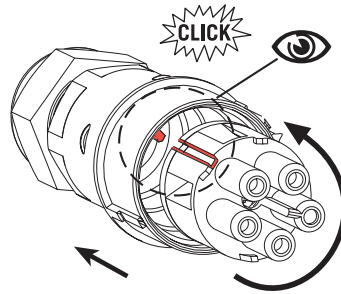
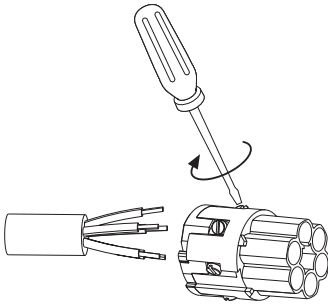

- Screw type connection method; soldering or special tools are not required.
- A flathead (minus) screwdriver of tip width 3mm is recommended.
- Screws may be screwed in firmly. Use a screwdriver with proper grip handles to loosen it.

THB405 dimensions

- DXF/DWG/PDF drawings available on our website.

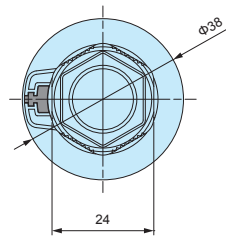
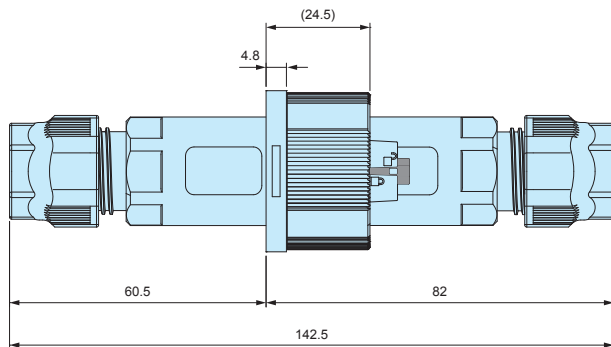

Sealing insert

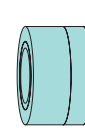

Cable diameter
Φ7mm ~ Φ9mm

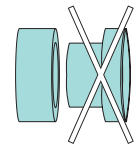

Cable diameter
Φ9mm ~ Φ13.5mm

- Applicable cable size range can be expanded by removing the inner sealing insert.

Product no. / Details

Product no.	Cable range	Number of poles
THB405-6P	Φ7.0 ~ Φ13.5	6P
THB405-8P	Φ7.0 ~ Φ13.5	8P

SEALING SOCKET CAP for THB405 • 406



■ DXF/DWG/PDF drawings available on our website.



- Protect socket from dust or foreign objects when not in use. Material : Cap / Polyamide 66 • Ring / Silicone.
- Sealing socket caps are not waterproof.



Product no. / Details

Product no.	Suitable models
6DB058000	THB405 • THB406 - Socket side

SEALING PLUG CAP for THB405 • 406

■ DXF/DWG/PDF drawings available on our website.



- Protect plug from dust or foreign objects when not in use. Material : Cap / Polyamide 66 • Ring / Silicone.
- Sealing plug caps are not waterproof.



Product no. / Details

Product no.	Suitable models
6DB00900C	THB405 • THB406 - Plug side

EXCLUSIVE TERMINAL INSTALLATION TOOL for THB405•406



- Terminal installation tool for 8P mode.
- Insert terminal into the tool and rotate it counterclockwise until a clicking sound can be heard.
- Not applicable for THB405-6P, 406-3P, and 406-6P models.

How to use



Insert terminal installation tool.



Rotate it counterclockwise to secure.

Product no. / Details

Product no.	Material	Suitable models
600052600	PA66GF	THB405-8P • THB406-8P

■ PA66GF = Glass fiber filled polyamide 66

SEALING INSERT for THA • THB • THS

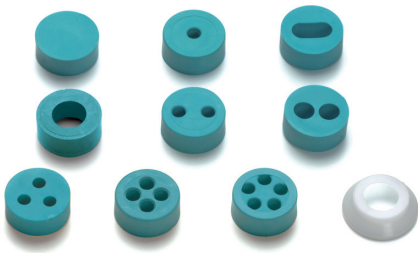

- Optional sealing insert for THA209, THB387L, 387LE, 389, 389E, 390, 399Y, 400, 402T, 405, 406, THS389 and 389E.
(Not applicable to be used for THB381, 381E, 387, 387E, 391 and 392 series.)
- Recommended to be used to change the compatible wire diameter, or for installation of multiple wires.
- 6000087LF cap can be used to prevent the rubber bushing from protruding, as well as stabilizing the waterproof performance when using wire of diameter 7.0mm or smaller.

Product no. / Details

Product no.	Appearance	Cable range	Material	Pack of
600013700		Blind insert without hole	TPE	10
600012700		11mm × 5.5mm	TPE	10
600037000		Φ4.0 ~ Φ6.5mm	TPE • POM	10 each
604001100		Φ5.5 ~ Φ9.5mm Use fixing cap for cables sized Φ7.0mm or smaller	TPE • POM	10 each
600013600		Φ2.0 ~ Φ4.0mm	TPE • POM	10 each
600012500		Φ2.0 ~ Φ4.0mm	TPE • POM	10 each
600030600		Φ4.5 ~ Φ6.0mm	TPE	10
600012600		Φ2.0 ~ Φ4.0mm	TPE	10
600018200		Φ2.0 ~ Φ3.5mm	TPE	10
600022400		Φ2.5 ~ Φ3.5mm	TPE	10
6000087LF		Cap for cables sized Φ7.0mm or smaller	POM	10

■ 6000087LF cap cannot be used with 600030600 and 600022400

EXCLUSIVE TIGHTENING TOOL for THB • THS



How to use

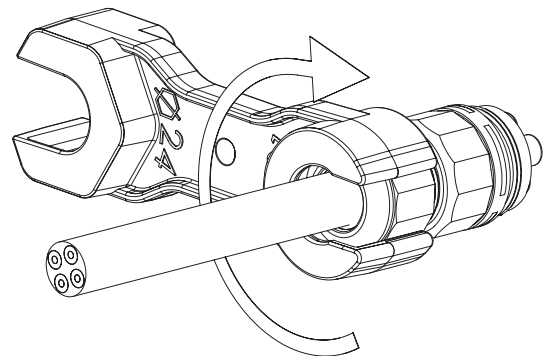

- Dedicated locking tool for tightening of the cable gland cap.

Product no. / Details

Product no.	Material / Color	Suitable models
6000337BC	PA66GF / Black	THB387 • 387E • 387L • 387LE • 389 • 389E • 390 • 390T • 391 • 392 • 399Y • 400 • 402T • 405 • 406 • THS389 • 389E

■ PA66GF = Glass fiber filled polyamide 66

EXCLUSIVE BRACKET for THB



- Optional bracket for affixing onto panels, poles etc.
- Recommended for affixing / securing connectors onto a surface.

■ DXF/DWG/PDF drawings available on our website.

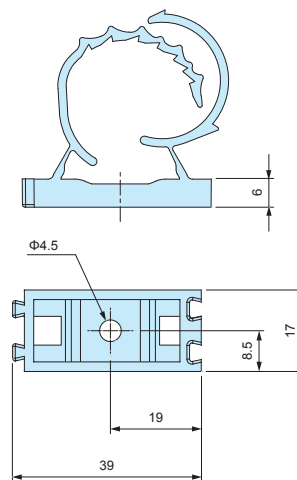

Product no. / Details

■ PA66 = Polyamide 66

Product no.	Material / Color	Suitable models
6000302CC	PA66 / Black	THB387 • 387L • 390 • 390T • 391 • 399Y • 400 • 402T • 405

Application Example - Waterproof Connector

Outdoor LED Lighting Connection

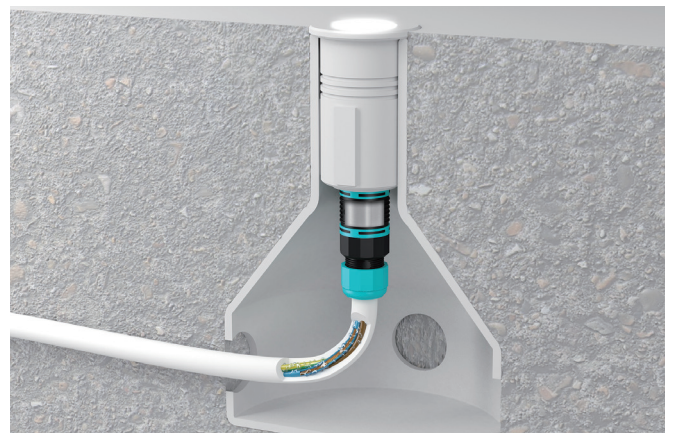
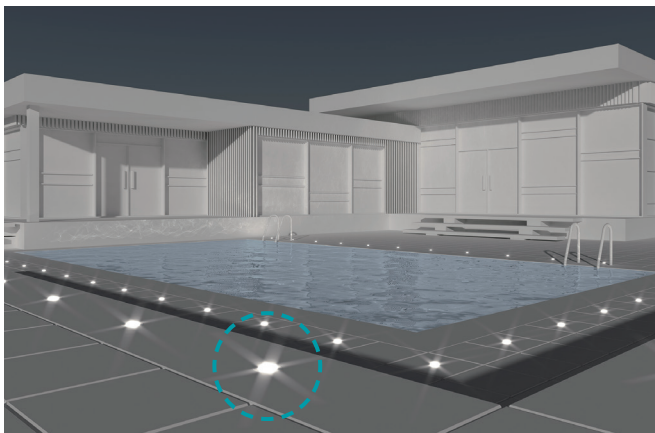
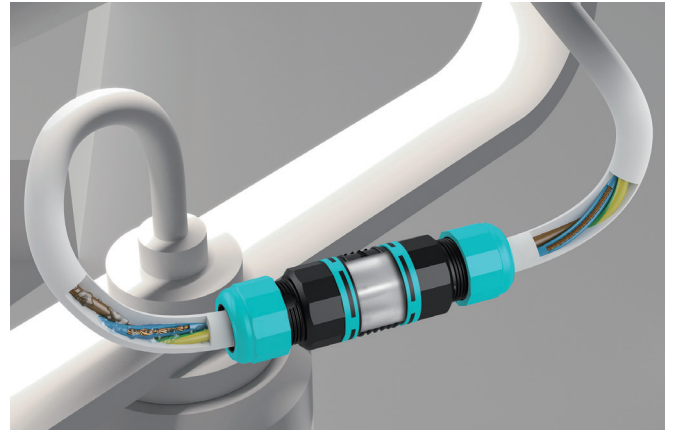
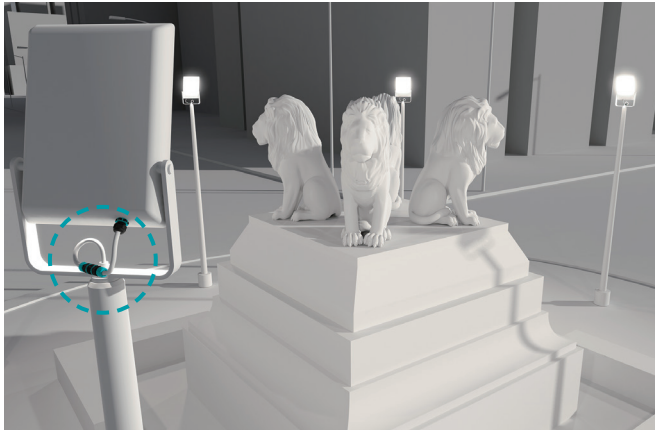

Application Example-1

Industrial Motor Connection

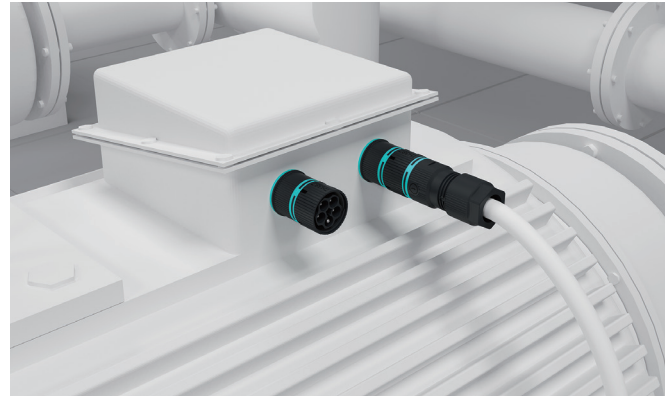
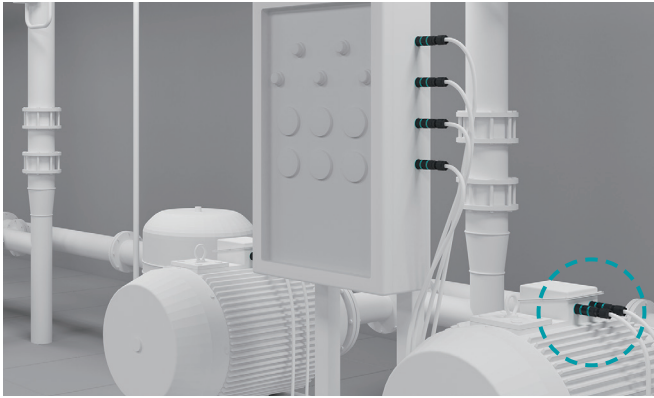

Sprinkler System Connection

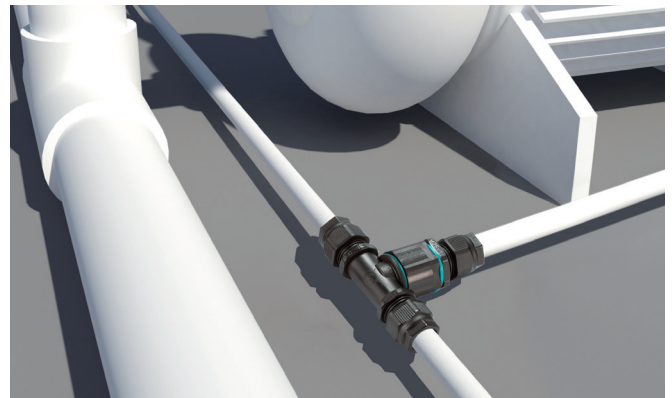
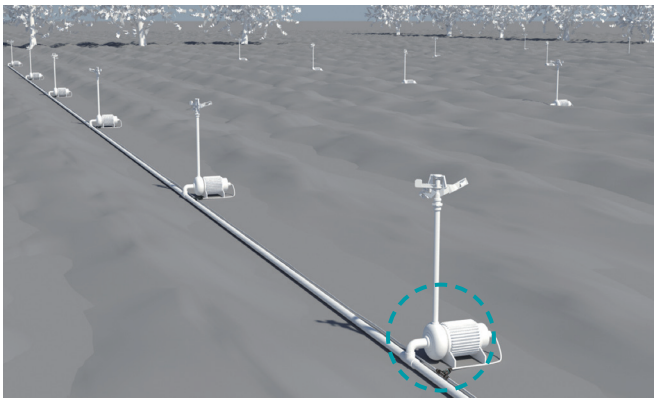

Power / Sensor Signal Relay in Factory Automation

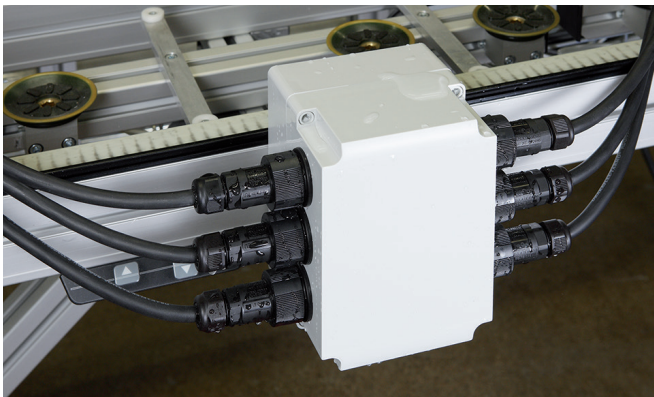

Machinery



Circuit Breaker Connector



Underground • Underfloor Wiring

