

PROTECTION CLASS (IP RATING)











IP67
is





● IEC60529 standard is a system for classifying the degrees of protection provided by the enclosures of electrical equipment, such as against dust and water.

IP

First digit : Solid particle protection

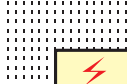
Second digit: Liquid ingress protection

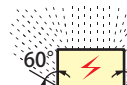
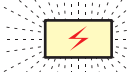
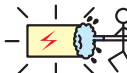
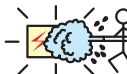
No.	Protection against ingress of solid foreign objects	Protection against access to hazardous parts
0	No Protection	No Protection
1	 Protected against solid objects over 50mm.	 Protected against accidental touch by a large surface of the body, such as by hands. (Tested with a 50mm diameter steel ball.)
2	 Protected against solid objects over 12.5mm.	 Protected against accidental touch by fingers or similar objects (Tested with a 12mm diameter, 80mm long articulated finger)
3	 Protected against solid objects over 2.5mm.	 Protected against accidental touch by tools or thick wires. (Tested with a 2.5mm diameter, 100mm long bar)
4	 Protected against solid objects over 1.0mm.	 1.0 Protected against accidental touch by most wires and screws. (Tested with a 1.0mm diameter, 100mm long wire)
5	 Protected against dust; limited ingress, no harmful deposits.	
6	 Complete protection against dust.	

No.	Protection against ingress of liquid
0	No Protection
1	 Dripping water (vertically falling drops) for 10 minutes.
2	 Vertically dripping water when tilted at 15° for 10 minutes (2.5 minutes per position).
3	 Spraying water (at any angle) of 0.07l/min up to 60° from the vertical for 10 minutes.
4	 Spraying water of 0.07l/min from all directions for 10 minutes.
5	 Jets of water projected by a φ6.3 nozzle of 12.5l / min from all directions at 1 min / 1m ² for at least 3 minutes.
6	 Powerful jets of water projected by a φ12.3 nozzle of 100l / min from all directions at 1 min / 1m ² for at least 3 minutes.
7	 Immersion, up to 1 meter depth (for 30 mins).
8	 Immersion (test depth and duration beyond IPX7 requirements)

69K

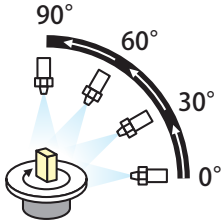

80 to 100 barrel steam jets at 80°C (±5°C) from a 0°, 30°, 60°, and 90° angle, at a distance of 100 ~ 150mm for 30 sec x 5 sets

A point of note for Waterproof Boxes

- For outdoor use, direct sunlight will accelerate the degradation of the box. For more information, please see page Outdoor Use - 1.
- For customers planning to attach their own original mounting brackets onto the waterproof boxes, it is recommended to mill larger holes with enough clearance to attach the bracket. If the milled hole and clearance is too small, it may cause irreparable damage to the box.
- Waterproof boxes made of Polycarbonate or ABS plastic material may be damaged if certain types of washing chemicals, solvents, oils, or thread locking adhesives are present on the box. Furthermore, paint not suitable to be used on plastic materials may also cause damage.

PLASTIC WATERPROOF BOX OUTDOOR USE

*Below are application examples for outdoor use of plastic waterproof boxes. Depending on the usage environment, effectiveness may vary.

Roof

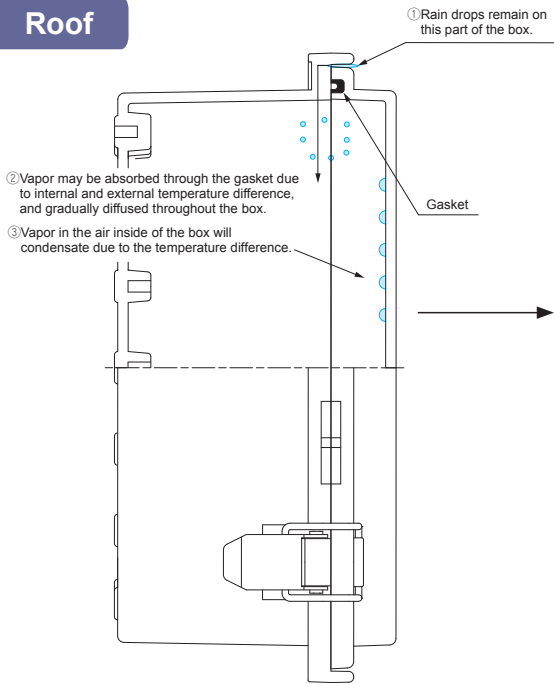

When installing waterproof box outdoors, installation under a roof, or attaching a roof accessory is recommended to prevent condensation inside the box.

This is especially so for transparent lid models which are affected by direct sunlight, causing the temperature inside of the box to be higher than non-transparent lid models.

Higher internal temperature (compared to the external part of the box) may cause vapor absorption, hence the importance of attaching a roof accessory.



■ Without roof attachment



■ With roof attachment

Protective Vent • Louver • Ventilation

Use to prevent condensation, as well as for ventilation. (Suitable parts vary depending on environment).

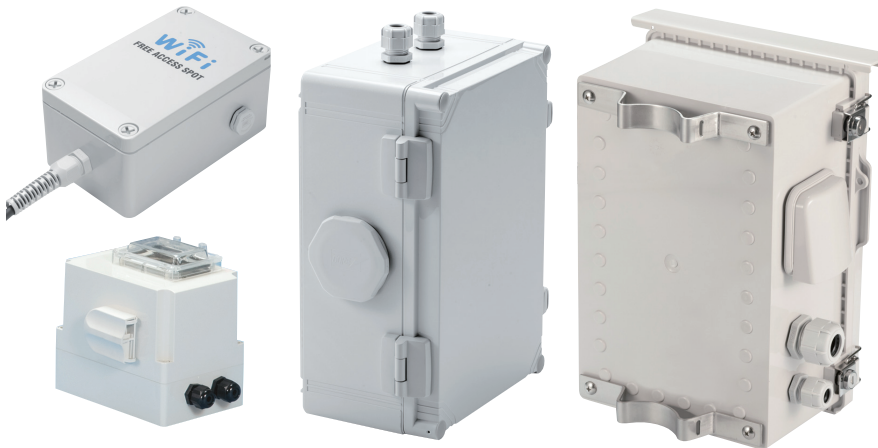

Protective Vent
PMF Series
See PMF pages



Louver
V Series
See V • VF pages



Ventilation Parts
VF series
See V • VF pages



Weather Resistant Coating

Weather resistant paint coating to protect against color fade and degradation. (ABS Plastic / 1 year exposure)

■ Before



■ After with coating



■ After without coating



WEATHERBILITY / DURABILITY TEST DATA for IP rated boxes

Weather resistance is the ability of a material to prevent corrosion, loss of material or any sort of deterioration due to prolonged exposure to harsh environmental and weather conditions.

The test data for our weather resistance waterproof/dustproof cases are as detailed below.

TEST DETAILS • TEST INSTRUMENT

Tester : Super Xenon Weather Meter SX75 - Suga Test Instruments Co., Ltd.
 (Testing under conditions closest to the spectral distribution of sunlight by utilizing a xenon lamp and filter system.)
 Irradiation Condition : 180 W/m² at 300 ~ 400nm
 Black panel humidity : 63±3 °C
 Relative Humidity : 50±10 %
 Cycle conditions : 120 minutes (18 min. irradiation + water spray and 102 min. irradiation)
 Test Time : 500 hours (continuous test)
 Radiation Exposure : 324 MJ/m²
 Measurements : Color measurements performed based upon JIS Z 8722 standard, with the results based upon JIS Z8781-4 standard.
 *Lesser color difference infers better weather resistance.

TEST DATA

*Test data results are reference data only; does not reflect actual usage conditions.

Before testing (plastic material color)



① ② ③ ④ ⑤ ⑥



After 500 hours testing (plastic material color)

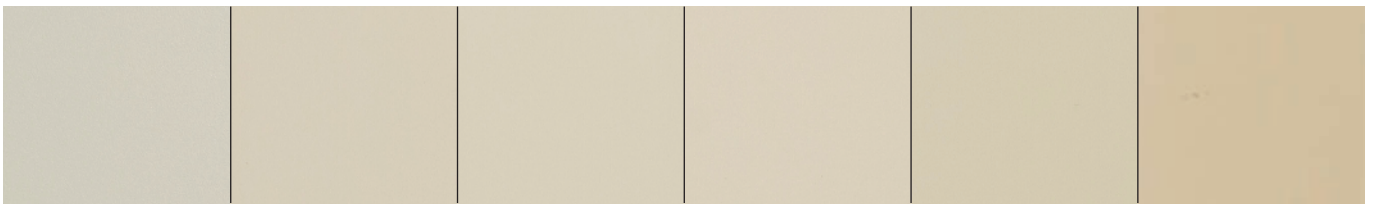

No.	Target box / Material	Test time	Color difference ΔEab
①	WP series - G color type ASA material	100 hrs.	0.9
		500 hrs.	3.3
②	SPCP • SPCM series (Body) Glassfiber-filled Polycarbonate material	100 hrs.	2.9
		500 hrs.	7.8
③	BCPC • BCPK series (Top cover) Polycarbonate material	100 hrs.	3.8
		500 hrs.	7.9
④	BCPC • BCPK series (Base) Glassfiber-filled Polycarbonate material	100 hrs.	4.7
		500 hrs.	8.6
⑤	SPCP • SPCM series (Cover) Polycarbonate material	100 hrs.	3.7
		500 hrs.	10.6
⑥	BCAP series ABS material	100 hrs.	3.6
		500 hrs.	10.8

Better weather resistance



Flame Resistance UL94 Standard

UL 94, the Standard for Safety of Flammability of Plastic Materials for Parts in Devices and Appliances testing, is a plastics flammability standard released by Underwriters Laboratories of the United States and is widely regarded as a global standard. The standard determines the material's tendency to either extinguish or spread the flame once the specimen has been ignited through [1] Horizontal burning test, and [2] Vertical burning test.

■ UL94 Definition

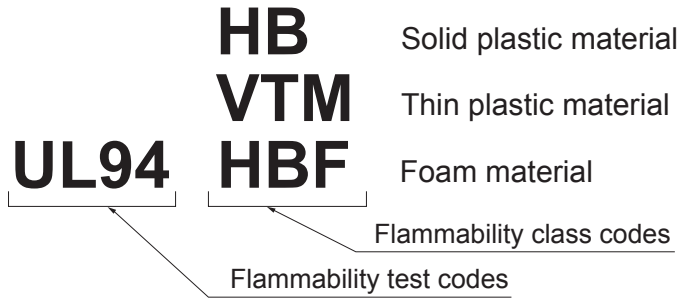

Testing Methods and Judge Standard for UL94HB and V Class (Solid Plastic Material)

Grade	94HB	94V-2	94V-1	94V-0	Test Specimen
Conditions					A1 : 5" x 1/2" x 0.125 ± 0.005" or minimum thickness thinner than 0.062"
Test Specimen	A1	A	A	A	A : 6" x 1/2 x minimum thickness 5" x 1/2" x maximum thickness Must thinner than 0.125"
Pre-treatment	I	I & II	I & II	I & II	Pre-treatment I : 40 hours in 23 ± °C and 50 ± 5%RH II : 168 hours in 70 ± 1°C
Number of Test Specimen	3	5 for Each Pre-treatment			Requirements
Flame Length	1" Pale Flame	3/4" Pale Flame			A : Not burning with flame combustion for more than 10 seconds after 1 flame application. B : Not burning with flame combustion for more than 30 seconds after 1 flame application. C : Not exceeding 50 seconds of the total flaming combustion time for the 10 flame applications for each set of 5 specimens D : Not exceeding 250 seconds of the total flaming combustion time for the 10 flame applications for each set of 5 specimens E : Not igniting the dry absorbent surgical cotton located 12" below by drip flaming particles from the specimens. F : Not having glowing combustion that persists for more than 30 seconds after the second removal of the test flame. G : Not having glowing combustion that persists for more than 60 seconds after the second removal of the test flame. H : Not burning with flaming or glowing combustion up to the holding clamp.
Testing Details	1. Each specimen is marked with two gauge marks, at 1" and 4" from one end. 2. A flame is applied to the end of the specimen for 30 second and then removed. The time for the flame between the two gauge marks is measured.	A flame is applied over 10 times to the center of the lower edge of the specimen for 10 seconds and removed. If burning ceases within 20 seconds, the flame is reapplied for an additional 10 seconds. If the specimen drips, particles are allowed to fall onto a layer of dry absorbent surgical cotton placed 12" below the specimen.			
Requirements	1 : Cease to burn before the flame reaches the 1" mark. 2 : Cease to burn before the flame reaches the 4" mark. 3 : Burn rate less than 115" per minute for the specimens thickness from 0.120" to 0.125". 4 : Burn rate less than 3.0" per minute for the specimen thinner than 0.120".	B, D, G and H	B, D, E, G and H	A, C, E, F and H	

■ UL GRADE CHART for PLASTIC

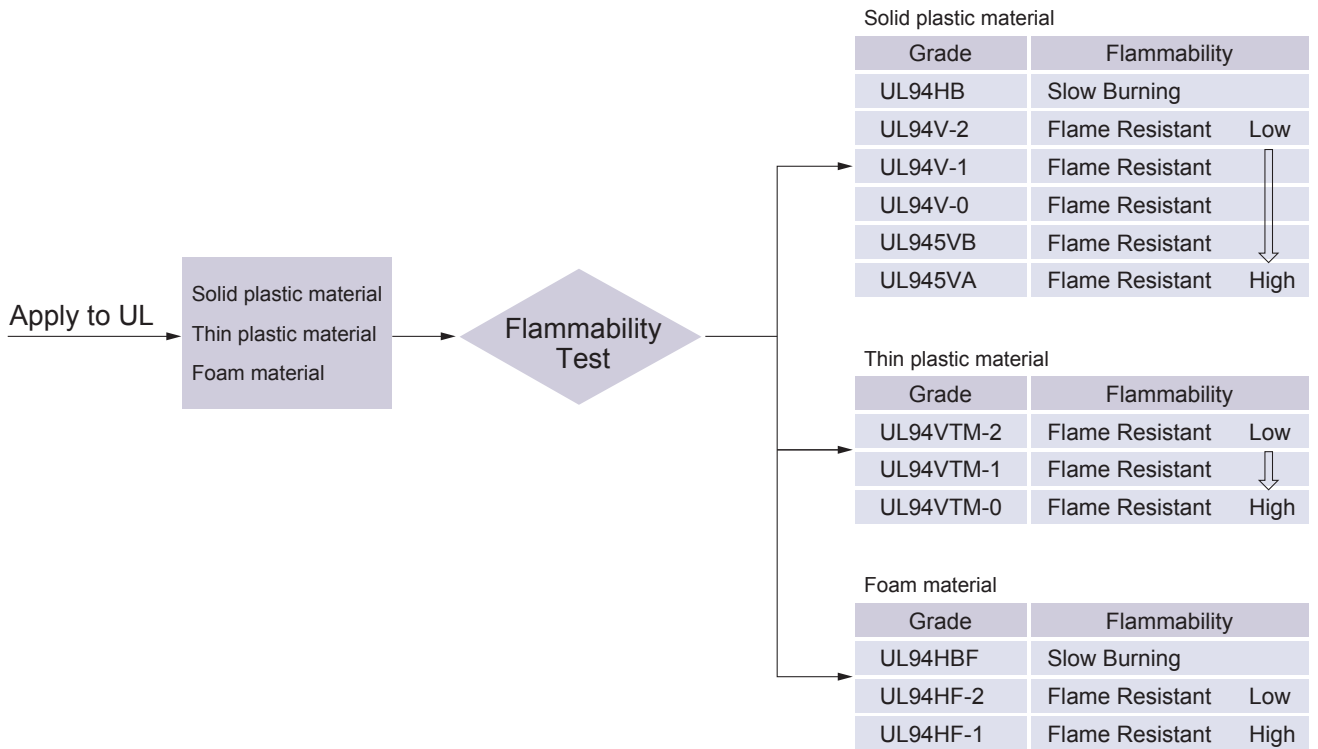

- UL grades are shown on each plastic product pages.
If listed as "ABS UL94V-0", it would refer to UL94V-0 being the primary material used in the product.

Flame Resistant UL758VW Standard

- Standard for appliance wiring material examined by [1] Horizontal burning test, and [2] Vertical burning test on the burning speed, the time for burning with flame, and flame on the dripping from the test piece. This standard is applied to our lead wire material on MP battery holders and LDN battery holders.

Flame Resistant UL510FR Standard

- Standard for Polyvinyl Chloride, Polyethylene and Rubber Insulating Tape examined by Vertical burning test with a specimen wrapped around a stainless steel bar on the burning speed, the time for burning with flame, and flame on the dripping from the test piece. This standard is applied to our CUS and CUL copper tapes and ALS and ALL aluminum tapes.

STANDARD TOLERANCE for MACHINING SERVICES

Our standard tolerance for machining services.

Hole/Cut Size • Hole/Cut Distance

Hole/Cut Size (A • B • C)

Dimension	Tolerance
0.5 ~ 3.0	±0.2
3.1 ~ 6.0	±0.2
6.1 ~ 30.0	±0.2
30.1 ~ 120.0	±0.3
120.1 ~ 400.0	±0.5
400.1 ~ 1,000.0	±0.8

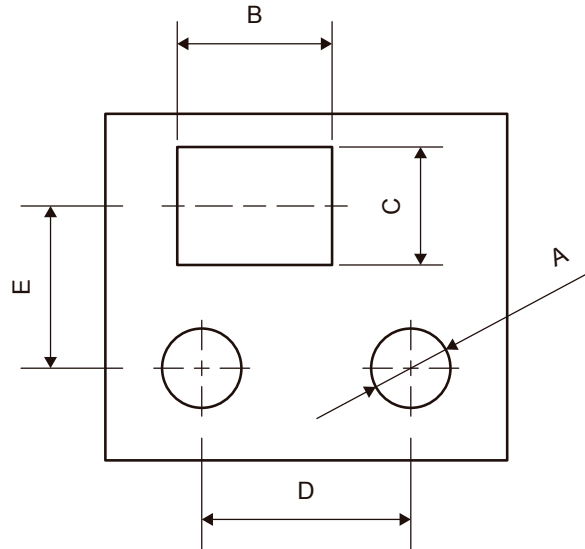

Hole/Cut Distance (D • E)

Dimension	Tolerance
0.5 ~ 3.0	±0.2
3.1 ~ 6.0	±0.2
6.1 ~ 30.0	±0.2
30.1 ~ 120.0	±0.4
120.1 ~ 400.0	±0.6
400.1 ~ 1,000.0	±0.8

Distance on Panel - F and G from ORIGIN • H and I from centerline

Punch Press • Laser Cutting (F • G • H • I)

Dimension	Tolerance
0. ~ 3.0	±0.2
3.1 ~ 6.0	±0.2
6.1 ~ 30.0	±0.2
30.1 ~ 400.0	±0.5
400.1 ~ 1,000.0	±0.6

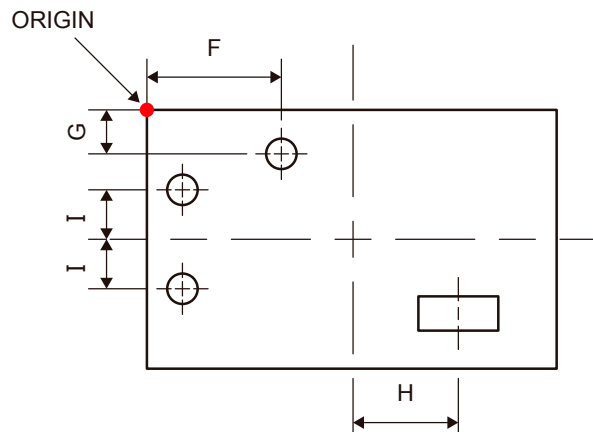

CNC Machining (F • G)

Dimension	Tolerance
0.5 ~ 3.0	±0.3
3.1 ~ 6.0	±0.3
6.1 ~ 30.0	±0.4
30.1 ~ 120.0	±0.6
120.1 ~ 400.0	±0.8
400.1 ~ 1,000.0	±1.0

CNC Machining (H • I)

Dimension	Tolerance
0.5 ~ 3.0	±0.5
3.1 ~ 6.0	±0.5
6.1 ~ 30.0	±0.6
30.1 ~ 120.0	±0.8
120.1 ~ 400.0	±1.0
400.1 ~ 1,000.0	±1.2

Distance on Enclosure - F and G from ORIGIN

Material : Extruded Aluminum (F · G)

Dimension	Tolerance
0.5 ~ 3.0	±0.5
3.1 ~ 6.0	±0.5
6.1 ~ 30.0	±0.6
30.1 ~ 120.0	±0.8
120.1 ~ 400.0	±1.0
400.1 ~ 1,000.0	±1.2

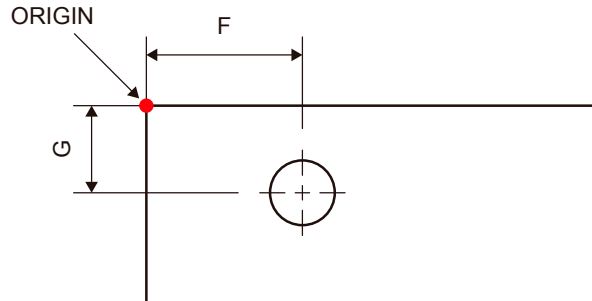

Material : Aluminum Diecast (F · G)

Dimension	Tolerance
0.5 ~ 3.0	±1.3
3.1 ~ 6.0	±1.3
6.1 ~ 30.0	±1.4
30.1 ~ 120.0	±1.6
120.1 ~ 400.0	±1.8
400.1 ~ 1,000.0	±2.0

Material : Plastic (F · G)

Dimension	Tolerance
0.5 ~ 3.0	±0.5
3.1 ~ 6.0	±0.5
6.1 ~ 30.0	±0.6
30.1 ~ 120.0	±0.8
120.1 ~ 400.0	±1.0
400.1 ~ 1,000.0	±1.2

Material : Plastic on BCAP, BCPC, BCAR, BCPR and BCPK series (F · G)

Dimension	Tolerance
0.5 ~ 3.0	±1.1
3.1 ~ 6.0	±1.1
6.1 ~ 30.0	±1.2
30.1 ~ 120.0	±1.4
120.1 ~ 400.0	±1.6
400.1 ~ 1,000.0	±1.8

Distance on Enclosure - H and I from Centerline

Material : Extruded Aluminum (H · I)

Dimension	Tolerance
0.5 ~ 3.0	±0.8
3.1 ~ 6.0	±0.8
6.1 ~ 30.0	±0.9
30.1 ~ 120.0	±1.1
120.1 ~ 400.0	±1.3
400.1 ~ 1,000.0	±1.5

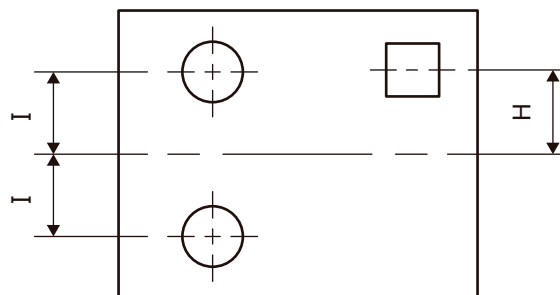

Material : Aluminum Diecast (H · I)

Dimension	Tolerance
0.5 ~ 3.0	±2.4
3.1 ~ 6.0	±2.4
6.1 ~ 30.0	±2.5
30.1 ~ 120.0	±2.7
120.1 ~ 400.0	±2.9
400.1 ~ 1,000.0	±3.1

Material : Plastic (H · I)

Dimension	Tolerance
0.5 ~ 3.0	±0.9
3.1 ~ 6.0	±0.9
6.1 ~ 30.0	±1.0
30.1 ~ 120.0	±1.2
120.1 ~ 400.0	±1.4
400.1 ~ 1,000.0	±1.6

Material : Plastic on BCAP, BCPC, BCAR, BCPR and BCPK series (H · I)

Dimension	Tolerance
0.5 ~ 3.0	±2.1
3.1 ~ 6.0	±2.1
6.1 ~ 30.0	±2.2
30.1 ~ 120.0	±2.3
120.1 ~ 400.0	±2.5
400.1 ~ 1,000.0	±2.8

Technical Data

Countersunk hole processing

When the thickness of the countersunk part of the screw is thicker than the material, the screw head will protrude outwards. In this case, please advise on how to handle this on your drawings.

All dimensions are in mm

Thread size	Countersunk height	Minimum thickness
M2	1.2	1.2mm
M2.5	1.45	1.45mm
M2.6	1.5	1.5mm
M3	1.75	1.75mm
M3.5	2.0	2.0mm
M4	2.3	2.3mm
M4.5	2.55	2.55mm
M5	2.8	2.8mm
M6	3.4	3.4mm
M8	4.4	4.4mm

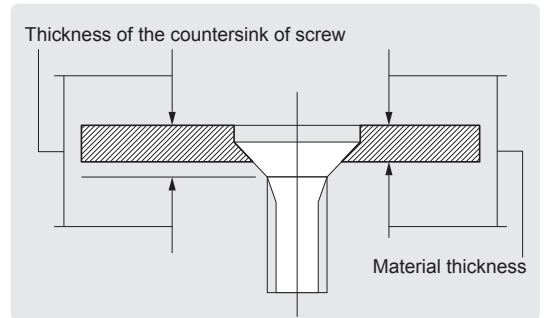

Fig.01

Should you encounter problems with protruding screw head/s, you could:

- Slightly deepen the head depth size to allow full insertion. (See Fig.01)
- Switch to having a standard circular hole.
- Consider switching to a smaller head screw.
- Change to using smaller screws.
- Or to let the protruding screw head remain protruded from the surface. (See Fig.02)

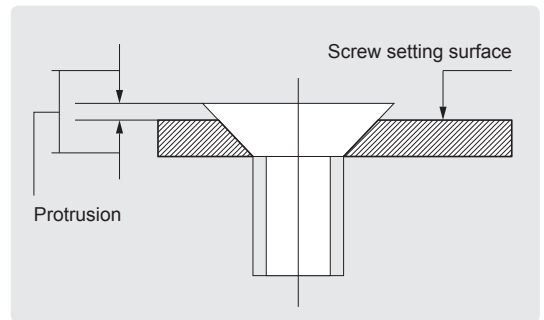

Fig.02

Threading

We can process thread holes from M1.7 to M32 and from PG7 to PG21 as per the chart below. Both plastic and metallic material types can be processed.

Metric Thread

Size	Pitch	Size	Pitch
M1.7	0.35	M11	0.75
M2	0.4	M12	1
M2.3	0.4		1.25
M2.5	0.45		1.5
M2.6	0.45	M13	1
M3	0.5	M16	1.5
M4	0.7	M18	1
M5	0.8	M20	1.5
M6	1	M25	1.5
M7	0.5	M32	1.5
M8	0.75		
	1.25		
M9	0.5		
	0.75		
M10	0.75		
	1		

PG Thread

Size	Pitch
PG7	1.27
PG9	1.41
PG11	
PG13.5	
PG16	1.588
PG21	



See Clinching-1, Self-clinching standoff / stud / nut



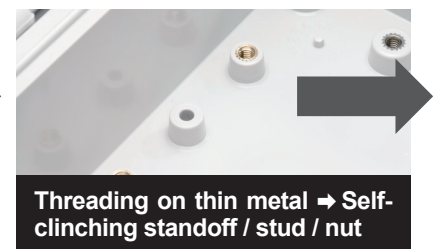









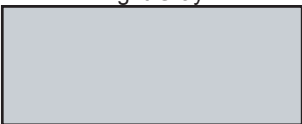

See Clinching-6, Inserts for plastic

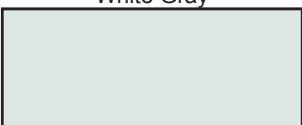

Color No. of TAKACHI Products

- The colors of the actual product may vary slightly from the color samples as shown below.
- Munsell Color No, RAL No. and Pantone No. shown below are similar matching colors (not exact matches).

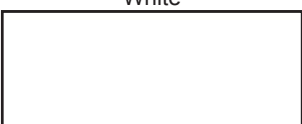
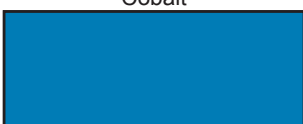
Plastic

<p>Gray</p>  <p>Munsell 5B6/1 Product Series : TMA</p>	<p>Gray</p>  <p>Munsell 5GY7/0.5 Product Series : SW-N</p>	<p>Gray</p>  <p>Munsell 5Y7/0.5 Product Series : CF • MH</p>	<p>Light Gray</p>  <p>Munsell 5GY8.5/0.5 Product Series : BCPC • BCPK • BCPR</p>
<p>Light Gray</p>  <p>Munsell 5GY8/0.5 Product Series : TMB</p>	<p>Light Gray</p>  <p>Munsell N7.5 Product Series : MX • FC • FCW • FCH • TW</p>	<p>Light Gray</p>  <p>Munsell 5Y8/0.5 Product Series : SW • SU • OP • MD</p>	<p>White Gray</p>  <p>Munsell 5R8/0.75 Product Series : BCAP • BCAR • BCAS • BCAL</p>
<p>White Gray</p>  <p>RAL7035 Product Series : WP • SPCP • SPCM</p>	<p>Off White</p>  <p>Munsell N8.75 Product Series : LC • TWN • TWF • PF • WH</p>	<p>Dark Gray</p>  <p>Munsell N3 Product Series : LC • TWF • PF • WP</p>	<p>Black</p>  <p>Munsell N1 Product Series : CS • SW • OP • TW • WH</p>
<p>White</p>  <p>Munsell N9.5 Product Series : CS • PS</p>	<p>Cobalt</p>  <p>Munsell 7.5B5/10 Product Series : PS</p>	<p>Green</p>  <p>Munsell 2.5GY8/12 Product Series : PS</p>	<p>Pink</p>  <p>Munsell 1R5/14 Product Series : PS</p>



Color No. of TAKACHI Products

- The colors of the actual products may vary slightly from the color samples as shown below.
- Munsell Color No, RAL No. and Pantone No. shown below are similar matching colors (not exact matches).

Silicone • Elastomer

Green  Pantone 389C Product Series : CSSC • TWSC	Yellow  Pantone 116C Product Series : CSSC • TWSC	Pink  Pantone 232C Product Series : CSSC • TWSC	Light Gray  Pantone CoolGray 5M Product Series : WC • CSSC
Cyan  Pantone 312M Product Series : CSSC	Navy  Pantone 653CP Product Series : TWSC	Black  Pantone ProcessBlack C Product Series : WC • CSSC • TWSC	Marine  Pantone 2736C Product Series : WC

Paint Colors

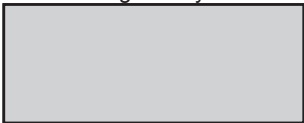
Light Gray  Munsell N8 Product Series : BDN • MS • MO	Gray  Munsell 2.5Y7/1 Product Series : MS • MO • CH	Black  Munsell N1 Product Series : MS • MO • CF • CH	Light Gray  Munsell 5Y8/0.5 Product Series : UC
---	---	---	---